

Trusted by Canada's busiest airport

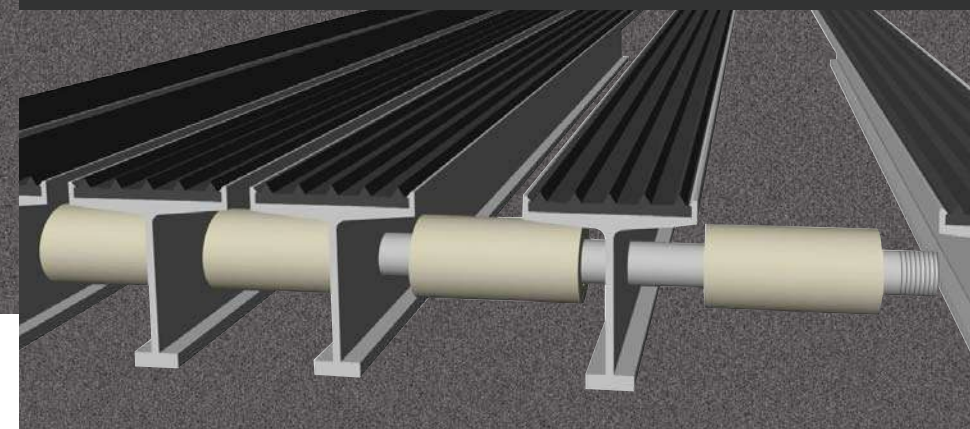

Distributed in Canada by:
MUL-T-MAT
 & SUPPLY CO.
 Phone: 905-738-3171
 Toll Free: (800) 567-MATS (6287)
 Fax: 905-738-8792
 www.mul-t-mat.com

kenagrille and ken-a-mat



Dimensionally permanent, dependable Foot Grilles and Floor Mats for all applications by K.N. Crowder Mfg. Inc.

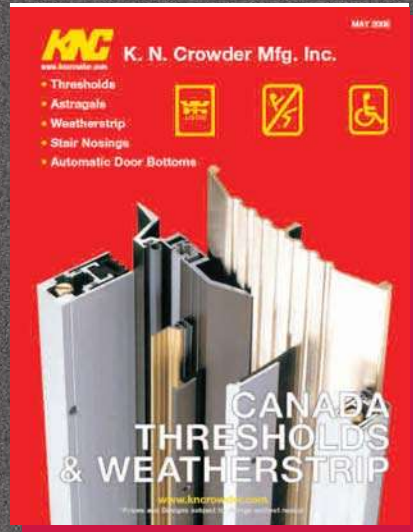

CANADA THRESHOLDS
 Where else but Canada with its extreme variations in climate, could one better test the use of weatherstrip and thresholds. Many thresholds, astragals and weatherstrip are anti-slip, handicap and fire-rated, in a variety of finishes.

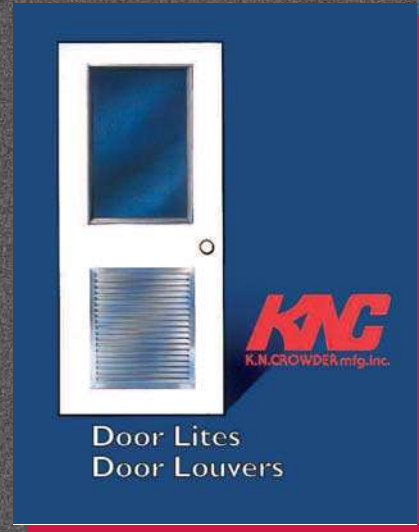

DOOR LITES AND DOOR LOUVERS
 Catalogue highlights KEN-DOOR aluminum door lites, STEELITE steel door lites, steel and aluminum sight-proof door louvers, and steel adjustable "Z" blade louver systems with fire actuated closure mechanisms.



CROWDERTRACK
 Crowdertrack is committed to providing the Sliding Door Industry with quality engineered, durable, time-tested door hardware.

Distributed in Canada by:
MUL-T-MAT
 & SUPPLY CO.
 Phone: 905-738-3171
 Toll Free: (800) 567-MATS (6287)
 Fax: 905-738-8792
 www.mul-t-mat.com

Canadian owned & operated for over 50 years

KENAGRILLE Recessed Foot Grilles

Threaded 3/8" steel rods and nylon spacers enable our Grilles to be compressed during assembly for construction that is hard to beat. Unlike the wear that can occur with aluminum key-lock grilles, tough nylon spacers allow the grille components to "flex" and return under the stressful conditions that grilles are subjected to. Wear is minimal and the result is a quiet, durable grille that stands the test of time.

Information contained in this catalogue may be subject to change without notice.

General Specifications

Supply and install KENAGRILLE aluminum foot grilles in sizes and quantities indicated on drawings as manufactured by K.N. Crowder Mfg. Inc., Burlington, Ont. Aluminum tread bars shall be 6061-T6 alloy, joined together with 3/8" (9.525mm) diameter threaded steel rods, with nylon spacers at centres as required. Extruded aluminum frame shall be 6063-T5 alloy, corners to be neatly mitred and held together with corner brackets, for ease of assembly on-site.

All aluminum shall be mill finished.

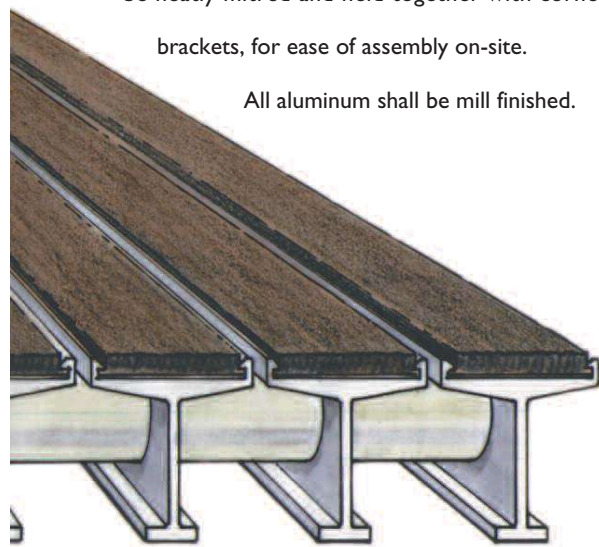

How to order your KENAGRILLE foot grille

To assist us in understanding your specific needs, and processing your order correctly, there are certain items that we need to know. In addition to the dimensions of the foot grille, we require the model number, type of frame, type of evaporation or drain pan (if required), and colour of insert (if applicable). This information can be found beside the foot grille, where it is pictured, or on the page showing additional information. Please specify them with your order, along with the dimensions and specifications of your project.

If any custom site conditions exist or if our specs require clarification, please do not hesitate to contact us for assistance.

Assess the dimensions of your project using this diagram. Projects may require division into panels, for ease of transport, installation and regular maintenance.

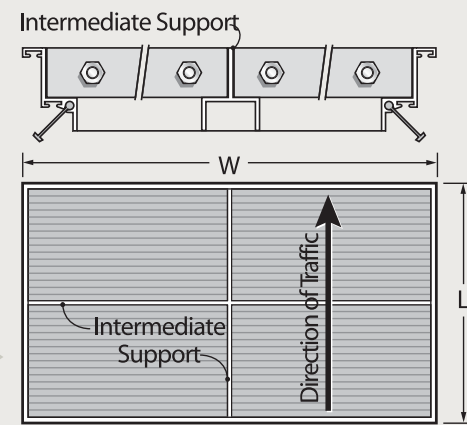

How to Specify KENAGRILLE

KenaGrille # FG-4 (vinyl insert)	Frame Type c/w Type GA frame	Special Options See page 9	Pan Type Evaporation pan 16 ga. Aluminum	Colour V-01 Black (if required)
---	---	--------------------------------------	---	--

WARRANTY - K.N. Crowder Mfg. Inc. warrants its purchasers that Ken-A-Grilles and Ken-A-Mats sold by it, when used for pedestrian purposes only, will be free of any defects in materials and workmanship for a period of one year from date of installation.

K.N. Crowder Mfg. Inc.'s liability is limited to the repair or replacement of units, which we agree are defective and will entertain no claims for consequential damages of any nature.

○ Available
N/A Not available

FINISHES		FRAME		
CLEAR ANODIZED	BRONZE ANODIZED	MA	MC	SF
○	○	○	○	○

AVAILABLE COLOURS



FM-4 Vinyl Mat

Serrated Lane® vinyl slip-resistant tread inserts provides a sure-footed surface.

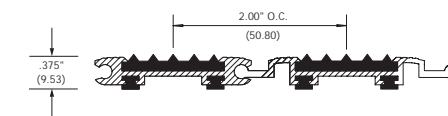

FINISHES		FRAME		
CLEAR ANODIZED	BRONZE ANODIZED	MA	MC	SF
○	N/A	○	○	○

FM-5 Aluminum Mat

Serrated Aluminum is economical and easily maintained, indented serrations provide slip-resistance.

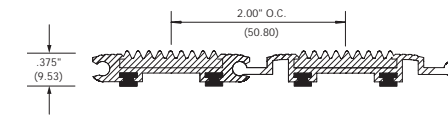

FINISHES		FRAME		
CLEAR ANODIZED	BRONZE ANODIZED	MA	MC	SF
○	○	○	○	○

AVAILABLE COLOURS



FM-8 Carpet Mat

Durable fusion-bonded cut-pile carpet inserts provide durable, slip and moisture resistant footing.

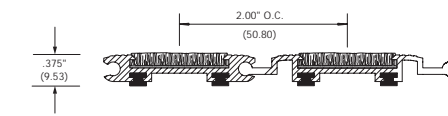

FINISHES		FRAME		
CLEAR ANODIZED	BRONZE ANODIZED	MA	MC	SF
○	○	○	○	○

AVAILABLE COLOURS

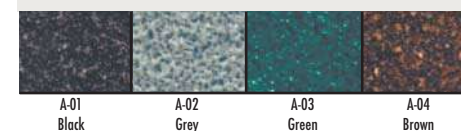

FM-14 Abrasive Mat

Extra slip-resistant Aluminum Oxide grit is imbedded in a factory-applied epoxy filler.

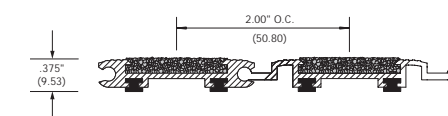

FINISHES		FRAME		
CLEAR ANODIZED	BRONZE ANODIZED	MA	MC	SF
○	○	○	○	○

AVAILABLE COLOURS



FM-15 Terrazzo Mat

Super slip-resistant Terrazzo Aggregate is permanently bonded to the base extrusion for aggressive high-traffic performance.

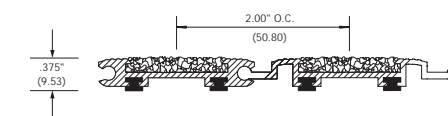

* Actual colours may vary from printed samples shown.

Distributed in Canada by:
MUL-T-MAT
& SUPPLY CO.

Phone: 905-738-3171
Toll Free: (800) 567-MATS (6287)
Fax: 905-738-8792
www.mul-t-mat.com

KEN-A-MAT

Mats

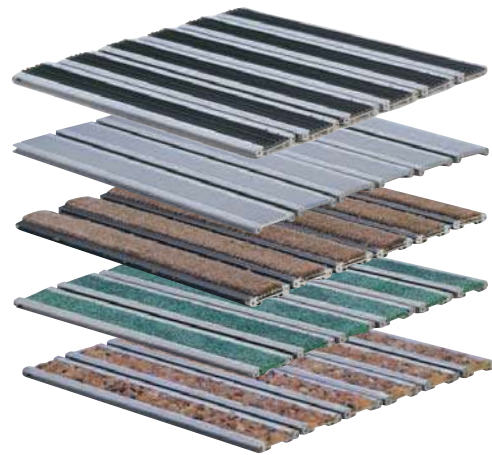

MAT TYPE	FINISHES		FRAME		
	CLEAR ANODIZED	BRONZE ANODIZED	MA	MC	SF
FM-4	○	○	○	○	○
FM-5	○	N/A	○	○	○
FM-8	○	○	○	○	○
FM-14	○	○	○	○	○
FM-15	○	○	○	○	○

○ Available N/A Not Available

KEN-A-MAT

proven performance in a tough low profile shape for recessed or surface applications. Tread Bars .375" (9.53) x 2.00" O.C. (50.80). Dimensions are the same for all models.

General Specifications

Supply and install KEN-A-MAT aluminum floor mats in sizes and quantities indicated on drawings as manufactured by K.N. Crowder Mfg. Inc. Surface shall be of serrated aluminum, Lanel® inserts, abrasive grit, terrazzo aggregate or of carpet having fusion-bonded cut pile for durability and moisture resistance. Colour of insert to be selected by consultant from our standard range of colours. Inserts shall be locked into treadrails. Treadrails to be fabricated from 6063-T5 aluminum alloy and joined in a continuous hinge system to allow easy roll-up.

How to order your KEN-A-MAT floor mat

To assist us in understanding your specific needs, and processing your order correctly, there are certain items that we need to know. In addition to the overall dimensions of the foot mat, we require the model number, type of frame, and colour of insert (if applicable). This information can be found beside the floor mat, where it is pictured. Please specify them with your order, along with the dimensions and specifications of your project.

If any custom site conditions exist or if our specs require clarification, please do not hesitate to contact us for assistance.

How to Specify KEN-A-MAT floor mat

Ken-A-Mat #	Frame Type	Colour
FM-8 (carpet insert) ClearAnodized	c/w Type MC frame	C-01 Charcoal

KEN-A-MAT Frames

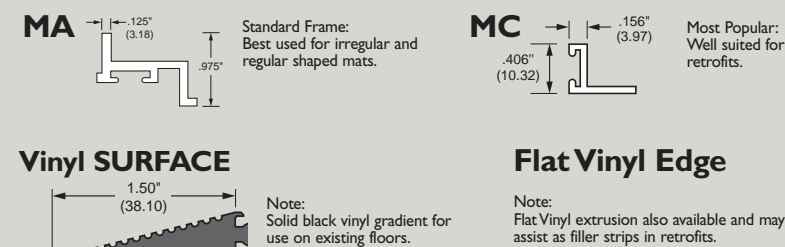

Grilles



- Available
- + Call for options
- N/A Not available
- * Cushions only suitable with GC frames

product summary

GRILLE TYPE	FRAME				PAN TYPE			SUPPORT			PG	FINISH
	GA	GB	GC	GCS	DRAIN	EVAP	NO PAN	HIDDEN	VISIBLE	CUSHIONS		
FG-1	○	○	○	N/A	○	○	○	○	○	N/A	4	STANDARD MILL FINISH CLEAR OR BRONZE ANODIZING AVAILABLE ON CERTAIN MODELS - CALL FACTORY FOR OPTIONS.
FG-2	○	○	○	N/A	○	○	○	○	○	N/A	4	
FG-2 HD	FRAME HD SEE PAGE 4			N/A	○	○	○	○	○	N/A	4	
FG-5	○	○	○	○	○	○	○	○	○	*	5	
FG-10	N/A	○	N/A	○	○	○	○	○	○	N/A	5	
FG-11	○	○	○	N/A	○	○	○	○	○	N/A	5	
FG-12	○	○	○	N/A	○	○	○	○	○	N/A	6	
FG-16	FRAME GD/GB SEE PAGE 6			N/A	○	○	○	○	○	N/A	6	
FG-21	N/A	○	N/A	○	○	○	○	○	○	N/A	6	
FG-22	○	○	○	N/A	○	○	○	○	○	N/A	3	
FG-3	○	○	○	○	○	○	○	○	○	*	7	
FG-4	○	○	○	○	○	○	○	○	○	*	7	
FG-8	○	○	○	○	○	○	○	○	○	*	7	
FG-13	○	○	○	○	○	○	○	○	○	*	8	
FG-14	○	○	○	○	○	○	○	○	○	*	8	
FG-15	○	○	○	○	○	○	○	○	○	*	8	

* See frame/pan types and special options on pg. 9.

New FG-22

Aluminum extrusion with 1/2" walking surface. Grill depth is well suited for high traffic retail entrances with shopping cart accessibility. Provides clog-free easy maintenance.

Fits frame: GA, GB or GC.
.50" x 1.50" Tread Bar Dimensions

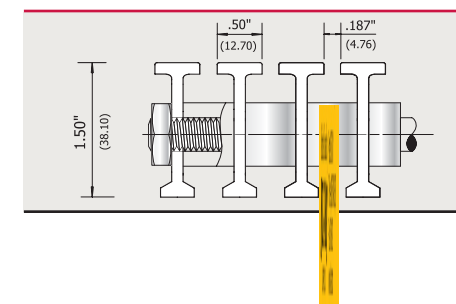

FRAME	PAN TYPE	SUPPORT	FINISH
GA GB GC	DRAIN EVAP NO PAN	HIDDEN VISIBLE CUSHIONS	STANDARD MILL FINISH
○ ○ ○	○ ○ ○	○ ○ ○	N/A



Distributed in Canada by:
MUL-T-MAT
& SUPPLY CO.

Phone: 905-738-3171
Toll Free: (800) 567-MATS (6287)
Fax: 905-738-8792
www.mul-t-mat.com

○ Available * Cushions only suitable with GC frames
 N/A Not available
 + Call for options See page 9

Foot Grilles

FG-1

Aluminum Flat Bar. Thin Line appearance works well with any decor.
 Free area: 55%.

* Special cleaning required to prevent debris from collecting between tread bars

Fits frame: GA, GB or GC
 .125" x 1.25" Tread Bar Dimensions

FRAME	PAN TYPE	SUPPORT	FINISH
GA	DRAIN	HIDDEN	STANDARD MILL FINISH
GB	EVAP	VISIBLE	
GC	NO PAN	CUSHIONS	N/A

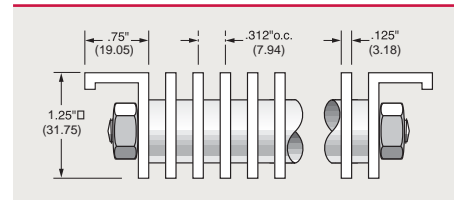

NEW & IMPROVED

FG-2

Aluminum extrusion with 5/16" walking surface. Tapered undercut provides clog-free, easy maintenance.

Fits frame: GA, GB or GC
 .312" x 1.25" Tread Bar Dimensions

FRAME	PAN TYPE	SUPPORT	FINISH
GA	DRAIN	HIDDEN	STANDARD MILL FINISH
GB	EVAP	VISIBLE	
GC	NO PAN	CUSHIONS	N/A

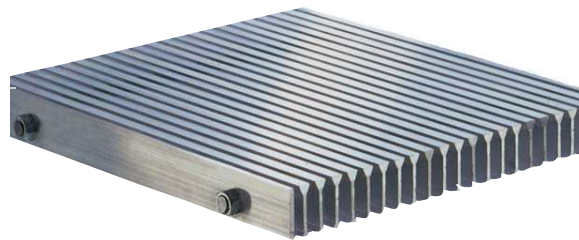
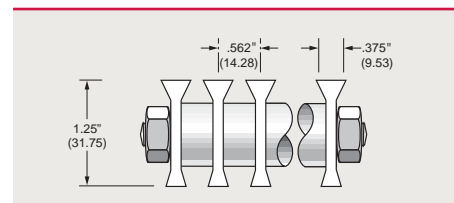

NEW & IMPROVED

FG-2 HD Heavy Duty Aluminum Grille

We have taken our most popular grille and made it even stronger for demanding traffic loads, i.e. automobile showrooms, building supply stores, etc.

Fits frame: HD only
 .312" x 2.50" Tread Bar Dimensions

FRAME	PAN TYPE	SUPPORT	FINISH
HD	DRAIN	HIDDEN	STANDARD MILL FINISH
	EVAP	VISIBLE	
	NO PAN	CUSHIONS	N/A

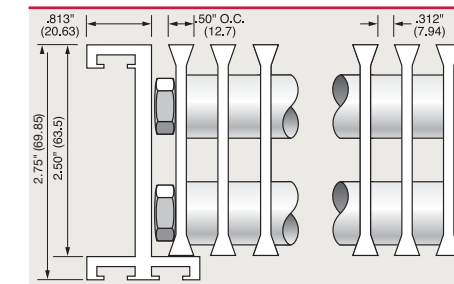

FRAME TYPES

Note:
 GA, GB and GC frames can be supplied with drain or evaporation pans- (drain pan application shown- GA, GB only)

All frames are available without pans

GA

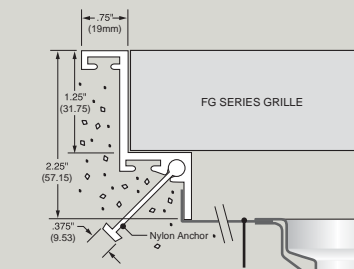

Drain Pan

- Frame also available with our 1.50" deep foot grilles
- Commonly used in new concrete floor applications

GB

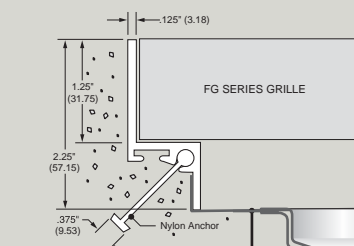

Drain Pan

- Frame also available with our 1" and 1.50" deep foot grilles
- Thin profile is best suited when minimal frame visibility is required i.e. tile floor applications

GCS

Ideal for 1" dp. foot grilles & special requirements

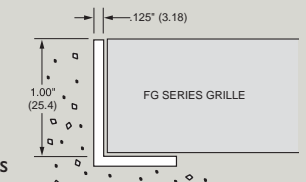

Shown without Pan

GC

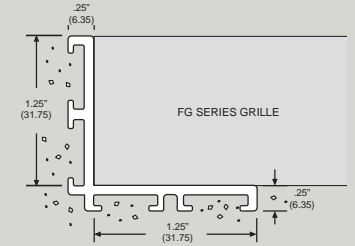

Shown without Pan

- Frame also available with our 1.50" deep foot grilles
- For installation in floors where depth is limited

Kenagrille Pans

Kenagrille pans provide a corrosion resistant catch basin and are further coated at masonry contact points for long maintenance life. We supply: 16 ga. aluminum, 20 ga. galvanized steel, 20 ga. stainless steel, for an evaporation or drain pan application. Please specify which type is required (if applicable).

Special Options: CL - Continuous Line

By using hidden supports and panel joints, grilles can be constructed as if to appear continuous. Some limitations and premiums may apply. Hidden or Intermediate Supports may or may not apply to this special option. Contact KN.Crowder Mfg. Inc. to see if this option is available for your application.

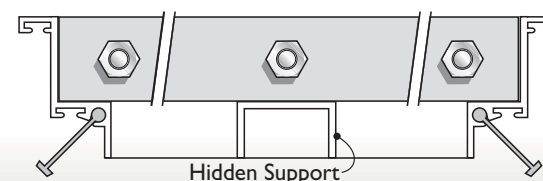

VC - Vinyl Cushions

Designed to provide added cushioning and sound suppression in level bed applications, with frame type GC or GCS only.

For grilles:
 FG-3, 4, 5, 8, 13, 14, or 15.

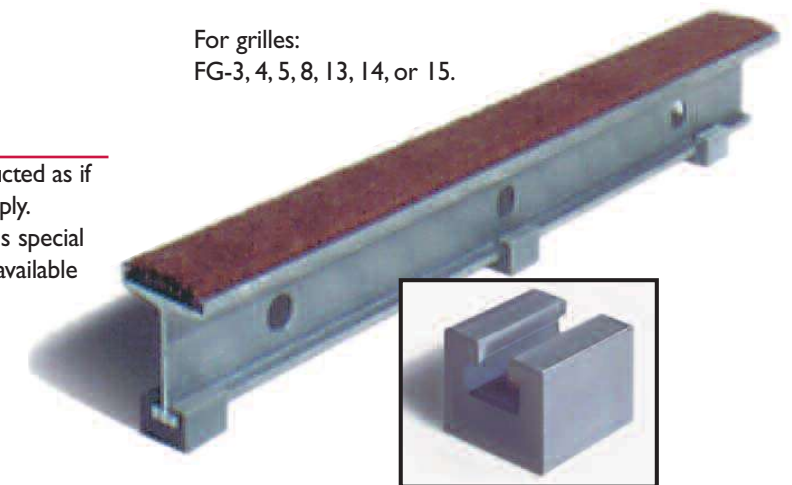

Not recommended for pan applications.

- Available
- N/A Not available
- + Call for options
- * Cushions only suitable with GC frames
- See page 9

- Available
- N/A Not available
- + Call for options
- * Cushions only suitable with GC frames
- See page 9

FG-13, FG-14 Abrasive Grille

FG 13: Extra slip-resistant Aluminum Oxide grit is imbedded in a factory-applied epoxy filler.

Fits frame: **GA, GB or GC.**

1.00" x 1.50" Tread Bar Dimensions

ABRASIVE GRILLE STYLE

FRAME	PAN TYPE	SUPPORT	COLOUR
GA GB GC	DRAIN EVAP NO PAN	HIDDEN VISIBLE CUSHIONS	AS SHOWN
○	○	○	*

AVAILABLE COLOURS

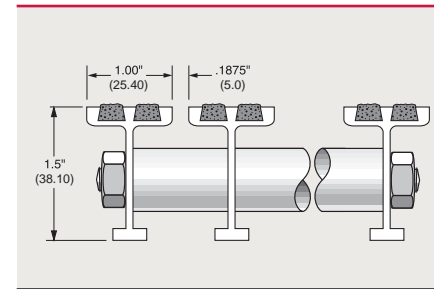
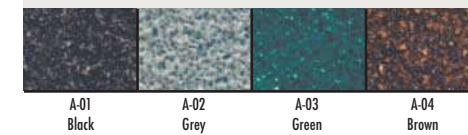

FG 14: Similar to above, with an even greater slip-resistant surface area.

Fits frame: **GA, GB or GC.**

1.312" x 1.50" Tread Bar Dimensions

ABRASIVE GRILLE STYLE

FRAME	PAN TYPE	SUPPORT	COLOUR
GA GB GC	DRAIN EVAP NO PAN	HIDDEN VISIBLE CUSHIONS	AS SHOWN
○	○	○	*

AVAILABLE COLOURS

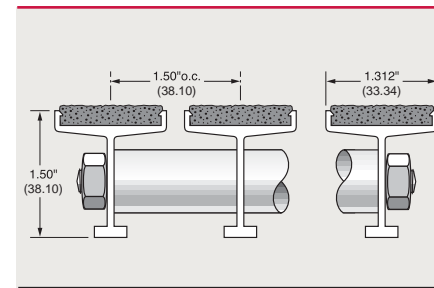
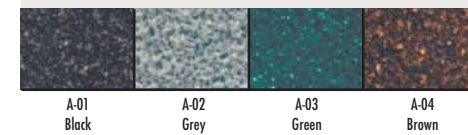

FG-15 Terrazzo Grille

Super slip-resistant Terrazzo Aggregate is permanently bonded to the base extrusion for aggressive high traffic performance.

Fits frame: **GA, GB or GC.**

1.312" x 1.50" Tread Bar Dimensions

TERRAZZO GRILLE STYLE

FRAME	PAN TYPE	SUPPORT	COLOUR
GA GB GC	DRAIN EVAP NO PAN	HIDDEN VISIBLE CUSHIONS	AS SHOWN
○	○	○	*

AVAILABLE COLOURS

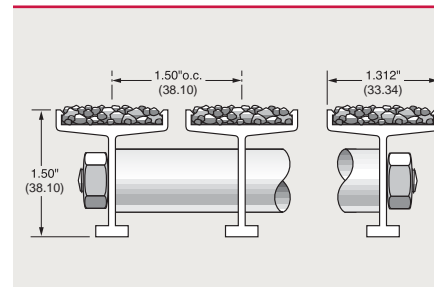

* Actual colours may vary from printed samples shown.

FG-5

Serrated Aluminum T extrusion. Economical and easily maintained. Indented serrations provide slip resistance.

Fits frame: **GA, GB or GC.**

1.00" x 1.50" Tread Bar Dimensions

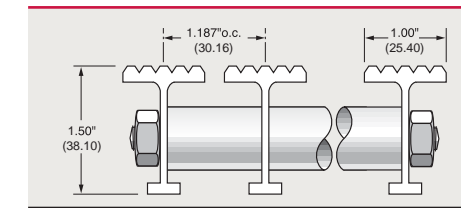

FRAME	PAN TYPE	SUPPORT	FINISH
GA GB GC	DRAIN EVAP NO PAN	HIDDEN VISIBLE CUSHIONS	STANDARD MILL FINISH
○	○	○	*

FG-10

Aluminum Flat Bar similar to FG-1 but lower in profile. Thin Line appearance works well with any decor.

* Special cleaning required to prevent debris from collecting between tread bars

Fits frame: **GB or GCS**

.125" x 1.00" Tread Bar Dimensions

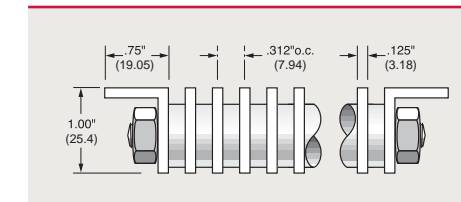

FRAME	PAN TYPE	SUPPORT	FINISH
GB GCS	DRAIN EVAP NO PAN	HIDDEN VISIBLE CUSHIONS	STANDARD MILL FINISH
○	○	○	N/A

FG-11

Aluminum T extrusion with 1/2" continuous bars.

Fits frame: **GA, GB or GC.**

.50" x 1.25" Tread Bar Dimensions

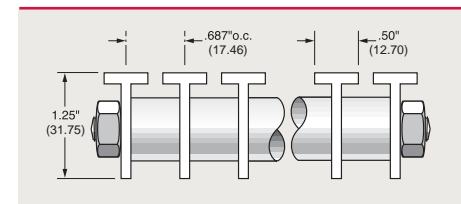

FRAME	PAN TYPE	SUPPORT	FINISH
GA GB GC	DRAIN EVAP NO PAN	HIDDEN VISIBLE CUSHIONS	STANDARD MILL FINISH
○	○	○	N/A

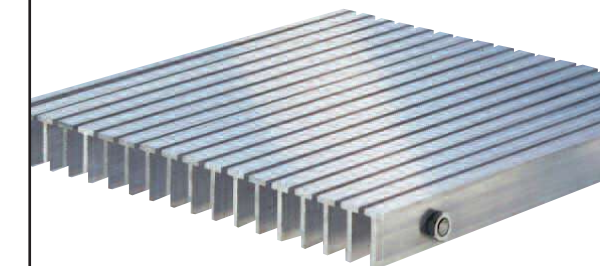
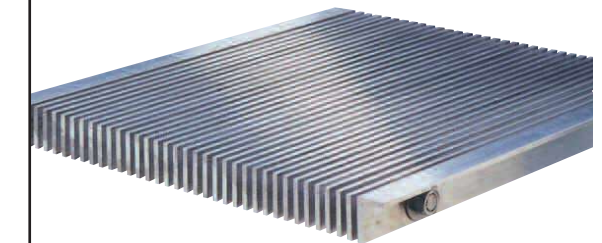
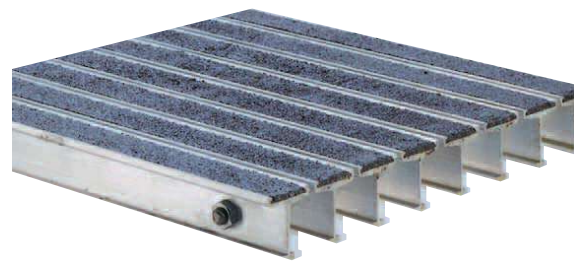
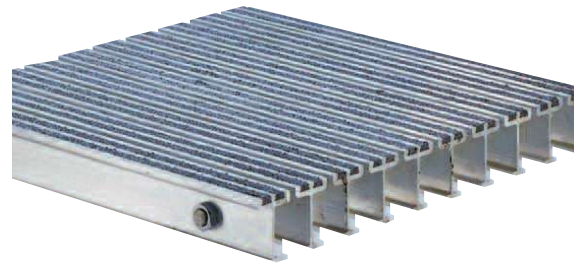

○ Available * Cushions only suitable with GC frames
 N/A Not available
 + Call for options See page 9

○ Available * Cushions only suitable with GC frames
 N/A Not available
 + Call for options See page 9

FG-12

Aluminum T extrusion with 1/2" squares and 3/16" spacing grid pattern. Well suited for multi-directional or angled traffic.

Fits frame: GA, GB or GC.

.50" x 1.25" Tread Bar Dimensions

FRAME	PAN TYPE	SUPPORT	FINISH
GA GB GC	DRAIN EVAP NO PAN	HIDDEN VISIBLE CUSHIONS	STANDARD MILL FINISH
○ ○ ○	○ ○ ○	○ ○ ○	N/A

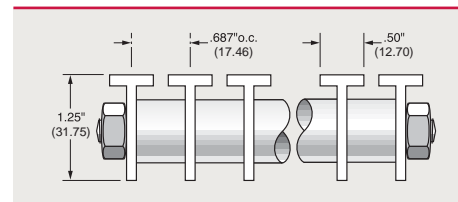

FG-16 Stainless Steel Foot Grille

Elegance and prestige best describe our stainless-steel foot grille constructed from 304 stainless-steel alloy. Fabricated as ruggedly as our aluminum foot grilles. Longevity and durability are unsurpassed. Top surfaces to be polished to a #4 finish. Mill finish is available.

* Special cleaning required to prevent debris from collecting between tread bars

Fits frame: GB or GD (Stainless Steel)

0.125" x 1.00" or 1.25" Tread Bar Dimensions

FRAME	PAN TYPE	SUPPORT	LEGEND
GD GB	DRAIN EVAP NO PAN	HIDDEN VISIBLE CUSHIONS	○ Available N/A Not available + Call for options
○ ○	○ ○ ○	○ ○ ○	N/A

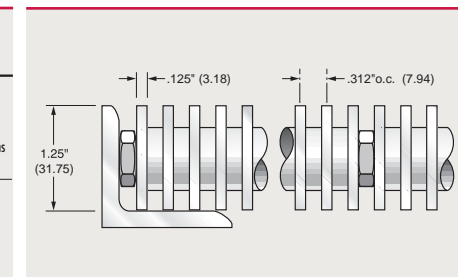

Shown with frame type GD

FG-21

Economical, best used in retrofit applications where depth is limited.

Fits frame: GB or GCS.

.312" x 1.00" Tread Bar Dimensions

FRAME	PAN TYPE	SUPPORT	FINISH
GB GCS	DRAIN EVAP NO PAN	HIDDEN VISIBLE CUSHIONS	STANDARD MILL FINISH
○ ○	○ ○ ○	○ ○ ○	N/A

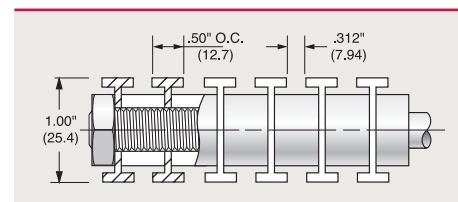

FG-3, FG-4 Vinyl Grille

FG 3: Lanel® vinyl slip-resistant tread, provides a sure-footed surface and excellent drainage. Note: Available in Black Only.

Fits frame: GA, GB or GC.

1.00" x 1.50" Tread Bar Dimensions

VINYL GRILLE STYLE

FRAME	PAN TYPE	SUPPORT	COLOUR
GA GB GC	DRAIN EVAP NO PAN	HIDDEN VISIBLE CUSHIONS	AS SHOWN
○ ○ ○	○ ○ ○	○ ○ ○	*

AVAILABLE COLOURS

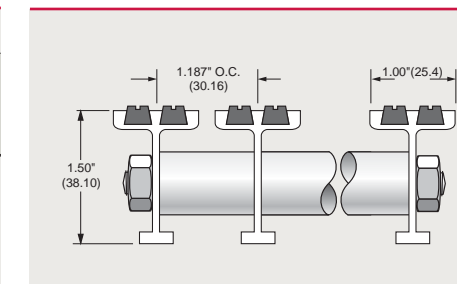

FG 4: Similar to above, with an even greater slip-resistant surface area.

Fits frame: GA, GB or GC.

1.312" x 1.50" Tread Bar Dimensions

VINYL GRILLE STYLE

FRAME	PAN TYPE	SUPPORT	COLOUR
GA GB GC	DRAIN EVAP NO PAN	HIDDEN VISIBLE CUSHIONS	AS SHOWN
○ ○ ○	○ ○ ○	○ ○ ○	*

AVAILABLE COLOURS

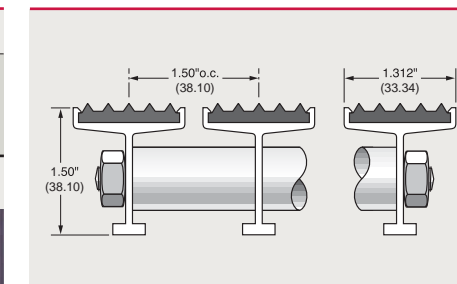

FG-8 Carpet Grille

Durable fusion-bonded cut-pile carpet inserts provide slip and moisture resistant footing.

Fits frame: GA, GB or GC.

1.312" x 1.50" Tread Bar Dimensions

CARPET GRILLE STYLE

FRAME	PAN TYPE	SUPPORT	COLOUR
GA GB GC	DRAIN EVAP NO PAN	HIDDEN VISIBLE CUSHIONS	AS SHOWN
○ ○ ○	○ ○ ○	○ ○ ○	*

AVAILABLE COLOURS

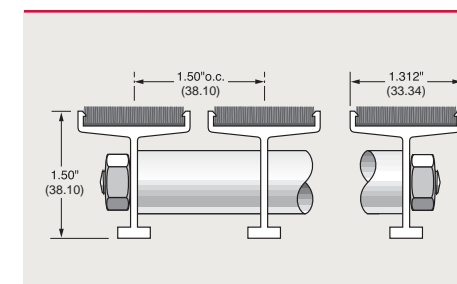

* Actual colours may vary from printed samples shown.

